

Line 100-120-125-127

Comandi a pannello con corpo in tecnopolimero
Panel mounting actuators with technopolymer body

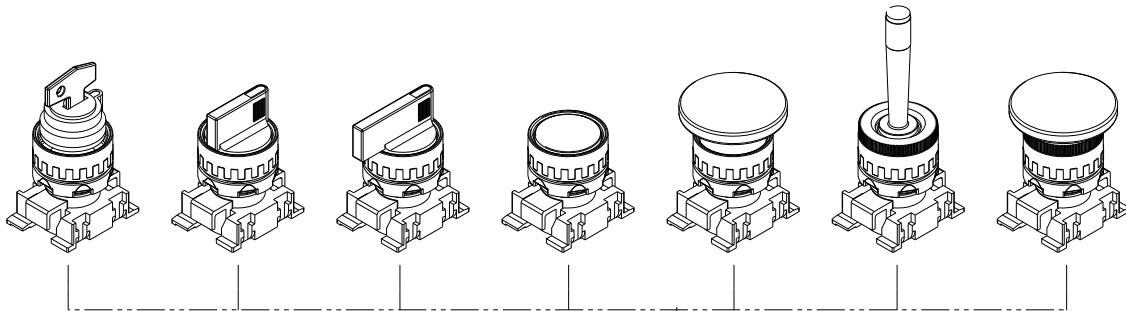

Misure di foratura Drilling Measures

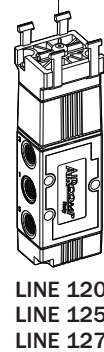
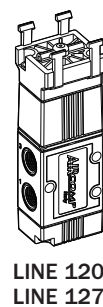
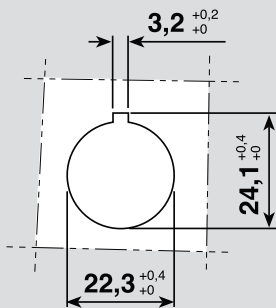

NB: I codici e le caratteristiche delle microvalvole linea 100 per comandi manuali a pannello, sono consultabili a pagina 8.

NB: For codes and features of microvalves line 100 with manual panel mounting actuator, refer to page 8.

Selettore a chiave 2 posizioni. Corpo in tecnopolimero, elemento frontale rotondo.

2 Positions key selector. Technopolymer body, round front element.



	POSITION	CODE	REF.
	1	1003A00031	RT201N SELETTORE (2 POSIZ.FISSE)

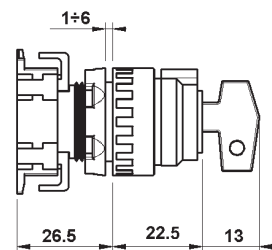

Selettore a leva corta 2 - 3 posizioni. Corpo in tecnopolimero, elemento frontale rotondo.

2 - 3 Positions short level selector. Technopolymer body, round front element.



	POSITION	CODE	REF.
	1	1003A00032	RT300N SELETTORE (2 POSIZ.FISSE)
	1	1003A00033	RT350N SELETTORE (2 POSIZ. CON RITORNO)
	1	1003A00034	RT313N SELETTORE (3 POSIZ. FISSE)
	2	1003A00035	RT383N SELETTORE (3 POSIZ. RIT. AL CENTRO)

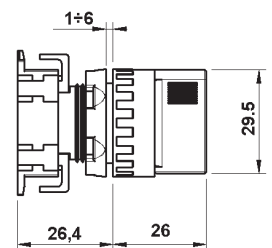





Line 100-120-125-127

Comandi a pannello con corpo in tecnopolimero
Panel mounting actuators with technopolymer body

Selettore a leva lunga 2 - 3 posizioni.
Corpo in tecnopolimero, elemento frontale rotondo.

2 - 3 Positions long level selector.
Technopolymer body, round front element.



POSITION	CODE	REF.
	1003A00036	RT400N SELETTORE (2 POSIZ.FISSE)
	1003A00037	RT450N SELETTORE (2 POSIZ. CON RITORNO)
	1003A00038	RT413N SELETTORE (3 POSIZ. FISSE)
	1003A00039	RT483N SELETTORE (3 POSIZ. RIT. AL CENTRO)

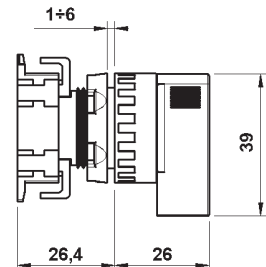

Pulsante protetto completo. Corpo in tecnopolimero, elemento frontale rotondo.

Protected push button. Technopolymer body, round front element.



COLOR	CODE	REF.
ROSSO - RED	1003A00074	RT010 PULSANTE + COVER
NERO - BLACK	1003A00075	RT010 PULSANTE + COVER
GIALLO - YELLOW	1003A00076	RT010 PULSANTE + COVER
VERDE - GREEN	1003A00077	RT010 PULSANTE + COVER
BIANCO - WHITE	1003A00078	RT010 PULSANTE + COVER
BLU - BLUE	1003A00079	RT010 PULSANTE + COVER

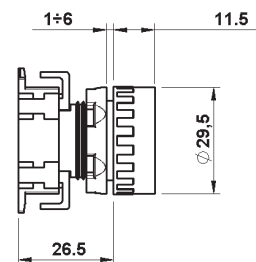

Fungo assiale ad impulso. Corpo in tecnopolimeri frontale rotondo.

Axial mushroom. Technopolymer body, round front element.



COLOR	CODE	REF.
ROSSO - RED	1003A00041	RT050R FUNGO
NERO - BLACK	1003A00042	RT050N FUNGO

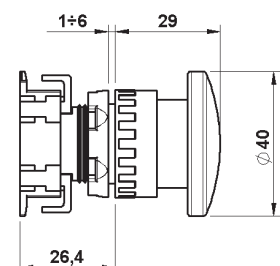

Line 100-120-125-127

Comandi a pannello con corpo in tecnopolimero
Panel mounting actuators with technopolymer body

Fungo assiale con sblocco. Corpo in tecnopolimero, elemento frontale rotondo.

Axial mushroom with turn reset. Technopolymer body, round front element.



COLOR	CODE	REF.
ROSSO - RED	1003A00052	RT065R - 40 FUNGO (DIAM. 40mm)
ROSSO - RED	1003A00057	RT065R - 60 FUNGO (DIAM. 60mm)

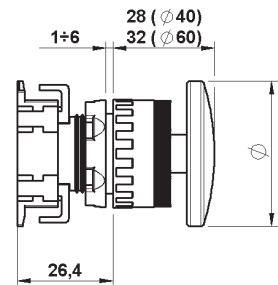

Leva oscillante. Corpo in tecnopolimero, elemento frontale rotondo.

Multi-directional lever. Technopolymer body, round front element.



COLOR	CODE	REF.
ROSSO - RED	1003A00046	RT054R LEVA

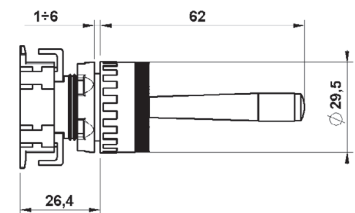

Contatto elettrico* per comando a pannello.

Electrical switch* for panel actuator.



COLOR	CODE	REF.
ROSSO - RED	1003A00050	CONTATTO NC
VERDE - GREEN	1003A00051	CONTATTO NO

* Compatibile solo su linea 100.
* Suitable for line 100 only.

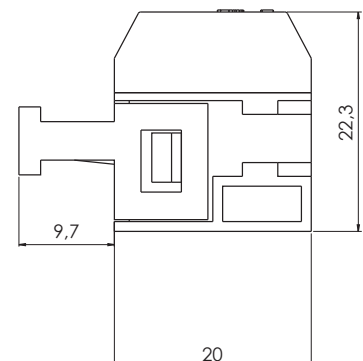

DATI TECNICI - TECHNICAL DATA

Tensione Isolamento - Isolation Voltage	Vi 660
Corrente Termica - Termichal Current	Ith 12A
Protezione - Protection	IP 20
Categoria Utilizzo - Category of use	AC 15