

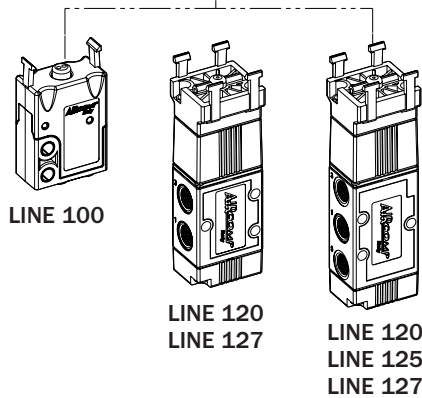

Drilling Measures

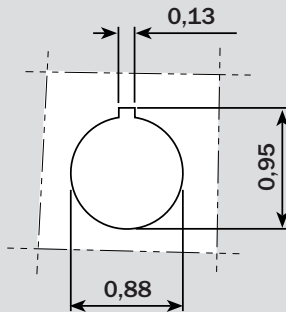

NB: For codes and features of microvalves line 100 with manual panel mounting actuator, refer to page 8.

2 Positions key selector. Technopolymer body, round front element.





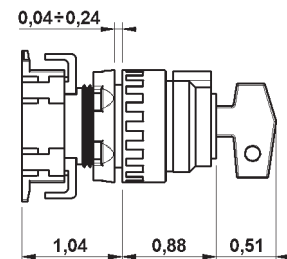

POSITION	CODE	REF.
	11003A00031	RT201N SELECTOR (2 STABLE POSITIONS)



2 - 3 Positions short level selector. Technopolymer body, round front element.





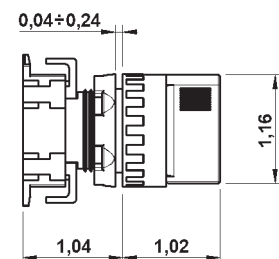

POSITION	CODE	REF.
	1003A00032	RT300N SELECTOR (2 STABLE POSITIONS)
	1003A00033	RT350N SELECTOR (2 RETURN POSITIONS)
	1003A00034	RT313N SELECTOR (3 STABLE POSITIONS)
	1003A00035	RT383N SELECTOR (3 RETURN POSITIONS)



2 - 3 Positions long level selector.
Technopolymer body, round front element.



POSITION	CODE	REF.
	1003A00036	RT400N SELECTOR (2 STABLE POSITIONS)
	1003A00037	RT450N SELECTOR (2 RETURN POSITIONS)
	1003A00038	RT413N SELECTOR 3 STABLE POSITIONS)
	1003A00039	RT483N SELECTOR (3 RETURN POSITIONS)

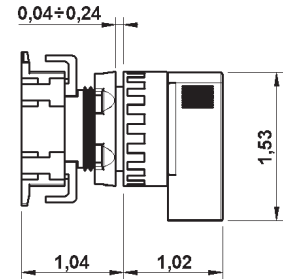

Protected push button. Technopolymer body, round front element.



COLOR	CODE	REF.
RED	1003A00074	RT010 BOTTON + COVER
BLACK	1003A00075	RT010 BOTTON + COVER
YELLOW	1003A00076	RT010 BOTTON + COVER
GREEN	1003A00077	RT010 BOTTON + COVER
BIANCO - WHITE	1003A00078	RT010 BOTTON + COVER
BLUE	1003A00079	RT010 BOTTON + COVER

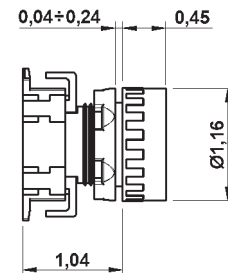

Axial mushroom. Technopolymer body, round front element.



COLOR	CODE	REF.
RED	1003A00041	RT050R MUSHROOM
BLACK	1003A00042	RT050N MUSHROOM

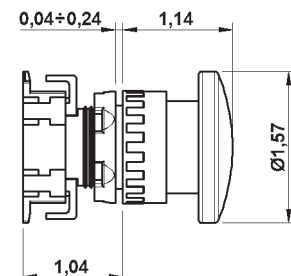

Line 100-121-126-127

Panel mounting actuators with technopolymer body

Axial mushroom with turn reset.
Technopolymer body, round front
element.



COLOR	CODE	REF.
RED	1003A00052	RT065R - 40 MUSHROOM 1,57 in (ø 40mm)
RED	1003A00057	RT065R - 60 MUSHROOM 2,36 in (ø 60mm)

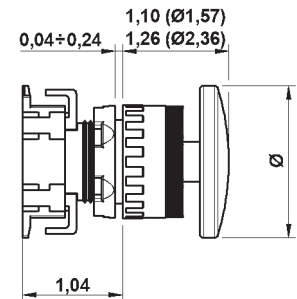

Multi-directional lever.
Technopolymer body, round front
element.



COLOR	CODE	REF.
RED	1003A00046	RT054R LEVER

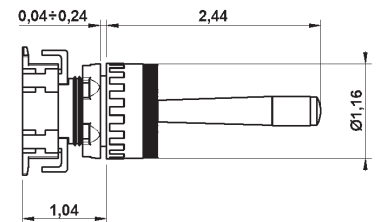

Electrical switch* for panel actuator.

COLOR	CODE	REF.
RED	1003A00050	CONTACT NC
BLACK	1003A00051	CONTACT NO

* Suitable for line 100 only.



DATI TECNICI - TECHNICAL DATA

Isolation Voltage	Vi 660
Termichal Current	Ith 12A
Protection	IP 20
Category of use	AC 15

